

Description

These product lines have set the industry standards for low-cost/high stability OCXOs. Developed with versatility in mind, the designs have enabled MTI to readily meet the changing demands of the marketplace. Utilized throughout the world in telecommunications and instrumentation applications, this family of products evolved from the tried and true design of the industry leading 250. The product lines offer numerous options in footprint, profile, and performance and are easily adapted to various applications.

Features

- STRATUM IIIe+ Performance
- Low Phase Noise
- Mounting & Connection Options

Applications

- STRATUM IIIe+ Telephony
- Point-to-Point Wireless
- GPS Receivers
- INMARSAT
- V-SAT
- Instrumentation
- Aerospace

250 Interface Control Drawing

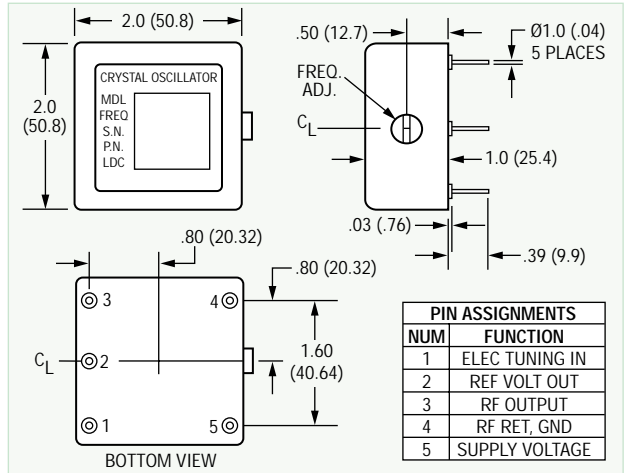

251 Interface Control Drawing

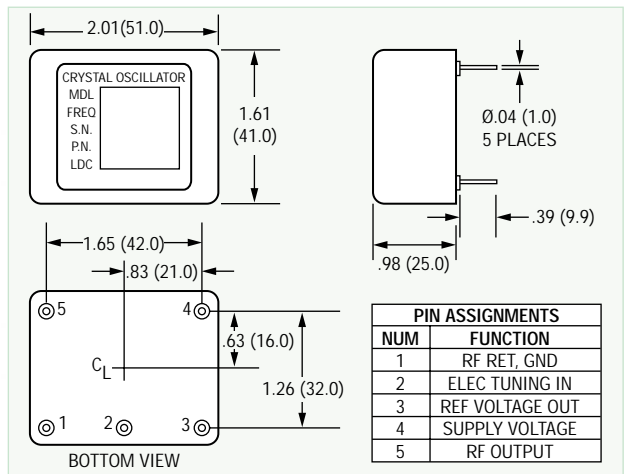



252 Interface Control Drawing

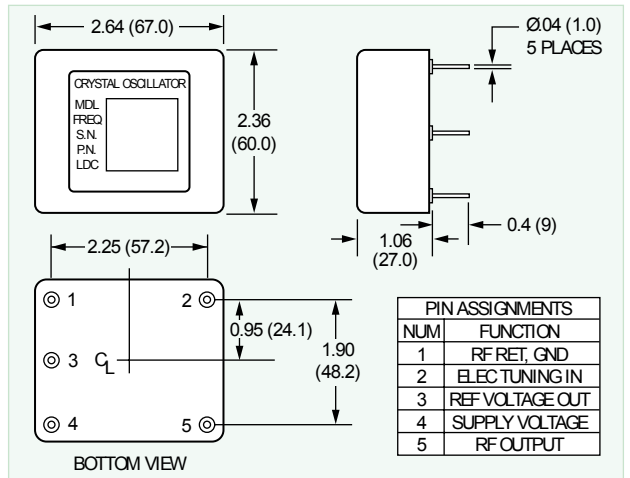

253 Interface Control Drawing

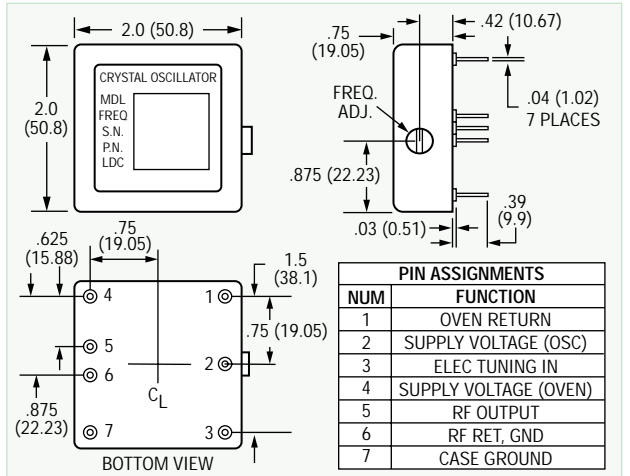

254 Interface Control Drawing

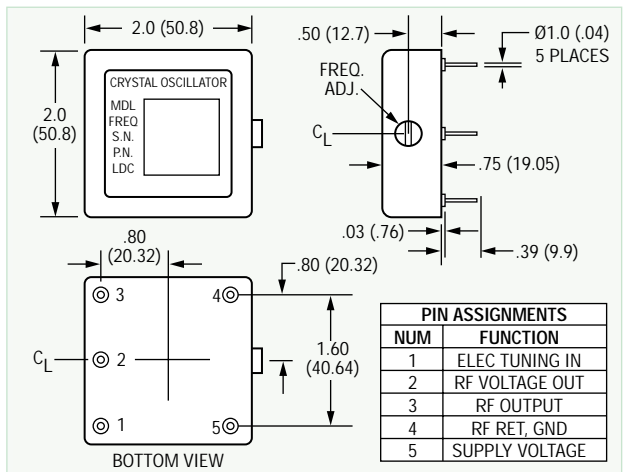

Continued on next page.

250 • 251 • 252 • 253 • 254 Series OCXO-Industry Standards



Phase Noise

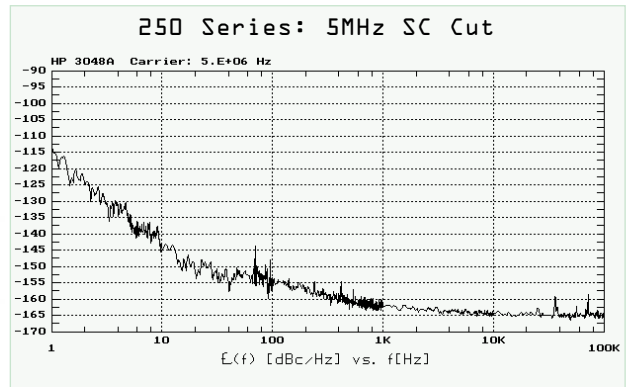

Performance Range	
Parameters	Available Range
Frequency	32 KHz to 60 MHz
Thermal Stability	2.00E-09 to 5.00E-07
Operating Temperature	-40°C to +85°C
Output	HCMOS/ACMOS
Supply Voltage	0 to +17dBm Sine
Tuning Voltage	+11 to +28V (DC)
	-10 to +10V (DC)

Super Low Phase Noise Model

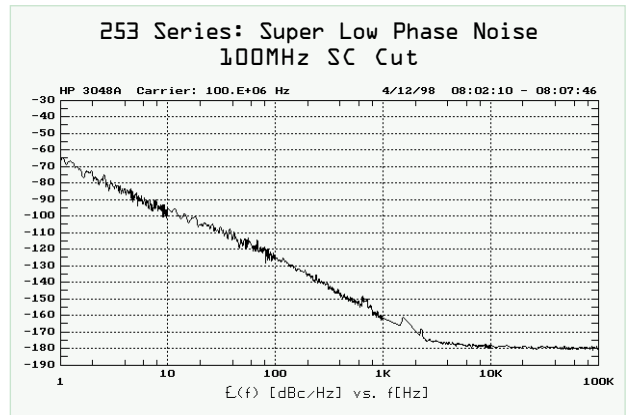

Design Note:

Base Models can be customized to your specifications using the performance range for this series.

250 Series Base Model Performance Guide

Frequency MHz	Crystal Cut	Thermal Stability*	Aging Rate per Day	Aging Rate per Year	Output	Phase Noise @ offsets (dBc/Hz)					
						1Hz	10Hz	100Hz	1kHz	10kHz	100kHz
4.096	SC	1.50E-08	1.00E-10	3.00E-08	9dBm Sine	-100	-130	-145	-155	-160	-160
5.000	AT	5.00E-08	1.00E-09	1.00E-07	9dBm Sine	-80	-110	-130	-140	-150	-150
5.000	SC	1.50E-08	1.00E-10	3.00E-08	9dBm Sine	-100	-130	-145	-155	-160	-160
5.000	AT	5.00E-08	1.00E-09	1.00E-07	HCMOS	-80	-110	-130	-140	-150	-150
5.000	SC	5.00E-09	8.00E-11	2.50E-08	9dBm Sine	-100	-130	-145	-155	-160	-160
6.144	SC	1.50E-08	2.00E-10	4.00E-08	9dBm Sine	-95	-125	-140	-150	-160	-160
8.192	SC	1.50E-08	1.00E-09	1.00E-07	HCMOS	-90	-120	-140	-155	-160	-160
10.000	AT	1.00E-07	3.00E-09	5.00E-07	9dBm Sine	-65	-95	-125	-140	-150	-150
10.000	SC	1.50E-08	1.00E-09	1.00E-07	9dBm Sine	-90	-120	-140	-155	-160	-160
10.000	SC	1.00E-08	8.00E-10	8.00E-08	9dBm Sine	-90	-120	-140	-155	-160	-160
10.000	SC	1.50E-08	1.00E-09	1.00E-07	HCMOS	-90	-120	-140	-155	-160	-160
13.000	SC	1.50E-08	2.00E-10	2.00E-08	HCMOS	-85	-115	-130	-140	-145	-145
13.000	SC	1.50E-08	2.00E-10	2.00E-08	9dBm Sine	-85	-115	-130	-140	-145	-145
16.384	AT	1.00E-07	3.00E-09	5.00E-07	HCMOS	-65	-95	-125	-140	-150	-150
16.384	SC	1.50E-08	1.00E-10	3.00E-08	9dBm Sine	-85	-115	-130	-140	-150	-150
16.384	SC	1.50E-08	1.00E-09	1.00E-07	9dBm Sine	-80	-110	-130	-140	-150	-155
30.000	AT	1.00E-07	3.00E-09	5.00E-07	5dBm Sine	-60	-90	-120	-135	-145	-150
39.000	AT	1.00E-07	3.00E-09	5.00E-07	5dBm Sine	-60	-90	-120	-135	-140	-145
50.000	AT	2.00E-07	5.00E-09	8.00E-07	5dBm Sine	-60	-90	-115	-130	-140	-145

* Temperature Range is from -30°C to +70°C



Thermal Stability

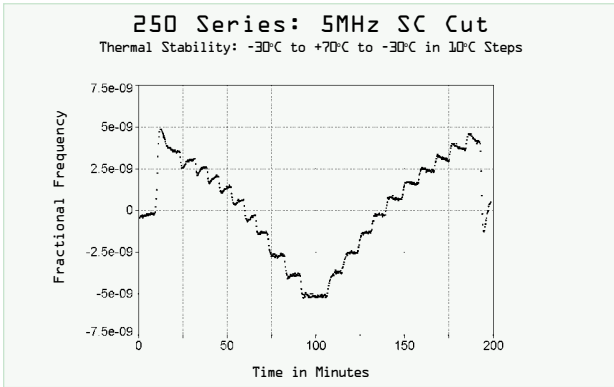

Aging



Thermal Stability

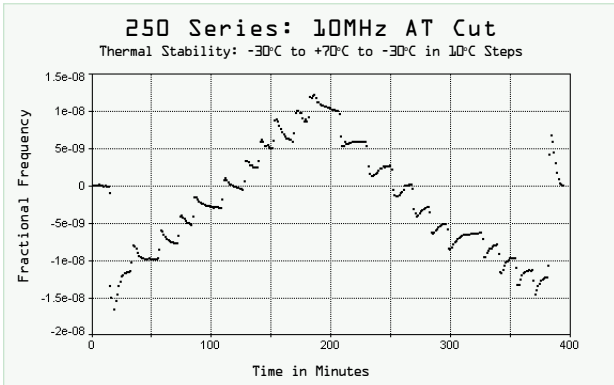

Aging

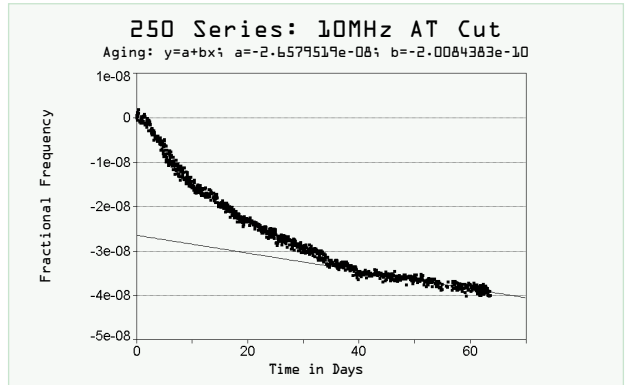

Short Term Stability	dF/dV	dF/dL	Warm Up Time (Min)	Warm Up dF/F	Warm Up Power (W)	Continuous Power (W) @25°C	Tuning (Min)	MTI Model #
2.00E-12	5.00E-10	5.00E-10	7	2.00E-08	5.0	1.7	±3.00E-07	250-0787
2.00E-11	1.00E-09	1.00E-09	5	2.00E-08	5.0	1.7	±1.30E-06	250-0503
2.00E-12	5.00E-10	5.00E-10	7	2.00E-08	5.0	1.7	±3.00E-07	250-0504
2.00E-11	1.00E-09	1.00E-09	10	2.00E-08	5.0	2.0	±1.00E-07	251-1507
2.00E-12	5.00E-10	5.00E-10	7	2.00E-08	5.0	1.7	±3.00E-07	250-0788
4.00E-12	5.00E-10	5.00E-10	7	2.00E-08	5.0	1.7	±5.50E-07	252-1133
1.00E-11	5.00E-10	5.00E-10	7	2.00E-08	5.0	1.7	±8.80E-07	253-0518
5.00E-11	4.00E-09	2.00E-09	10	2.00E-08	5.0	1.7	±3.60E-06	250-0501
1.00E-11	5.00E-10	5.00E-10	5	2.00E-08	5.0	1.7	±8.80E-07	250-0502
1.00E-11	5.00E-10	5.00E-10	7	2.00E-08	5.0	1.7	±7.00E-07	251-1533
1.00E-11	5.00E-10	5.00E-10	7	2.00E-08	5.0	1.7	±8.80E-07	254-0508
2.00E-12	5.00E-10	5.00E-10	7	2.00E-08	5.0	2.2	±3.00E-07	250-0789
2.00E-12	5.00E-10	5.00E-10	7	2.00E-08	5.0	2.2	±3.00E-07	253-0519
5.00E-11	4.00E-09	4.00E-09	7	2.00E-08	5.0	1.7	±3.60E-06	254-0512
5.00E-12	5.00E-10	5.00E-10	7	2.00E-08	5.0	2.2	±5.00E-07	251-1554
3.00E-11	2.00E-09	2.00E-09	7	2.00E-08	5.0	1.7	±7.00E-07	252-1134
7.00E-11	4.00E-09	4.00E-09	7	2.00E-08	5.0	2.2	±3.60E-06	250-0790
7.00E-11	4.00E-09	4.00E-09	7	2.00E-08	5.0	2.2	±3.60E-06	250-0791
7.00E-11	4.00E-09	4.00E-09	7	2.00E-08	5.0	2.2	±3.60E-06	250-0792